



Innate Console

The Innate Console possesses an inherent design language and integrity underpinned by honest construction and materials speaking in their most elemental states.

This restraint delivers a sense of quality and sophistication while also being supremely functional. The handcrafted pivot drawer and surface box offer an enviable level of user intimacy and tactile interaction.

Available in a variety of finishes and can be customised to suit most domestic or commercial settings.

Innate Console

Materials:

Custom materials available through
special order at jongoulder.com

Table Surface

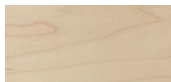

American
Rock Maple



American
White Oak



Tasmanian
Blackwood

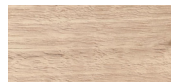

Tasmanian
Oak

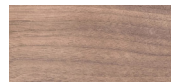

Walnut

Steel Frame

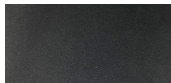

Black Powder
Coat

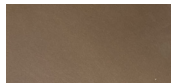

Electroplated
Aged Brass



Innate Console

Dimensions

H 900mm x L 1,500mm x D 460mm

Custom sizes available for special order
through jongoulder.com

Lead Time

8-12 Weeks

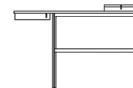
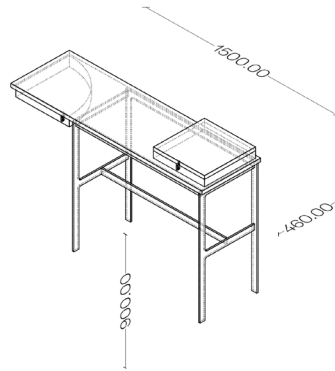

Care guide.

Wood

Avoid placing wooden furniture in direct sunlight or close to strong heat sources.

Also avoid placing hot or wet items directly on the wood.

Any stains should be removed quickly before they cause permanent damage to the surface of the wood. We recommend that you avoid partially covering the furniture with blankets or skins.

Cleaning Oil-treated wood / For everyday maintenance, wipe the table with a dry, clean cloth. For cleaning, use a clean cloth wrung in water, a solution of a water and a universal detergent e.g. soap flakes or a special product for oil-treated wood. Remove any soap residue immediately, using a clean, dry cloth.

For more thorough cleaning, you may use white spirit (mineral turpentine) to remove some of the oil membrane.

Do not apply a new coat of oil until the wood is completely dry.

Powder Coated or Electroplated Steel

Clean with a damp cloth wrung in a solution of water and a neutral detergent or soap flakes. Remove soap residue immediately using a clean, dry cloth. Avoid using scouring cream or scouring pads, as they may scratch the surface. Linoleum

Clean the legs using a firmly wrung cloth and mild soap. Avoid using scouring cream or scouring pads, as they may scratch the surface. Stainless steel can be cleaned using ethanol.

Fabric

Vacuum fabrics on a weekly basis to remove dust, dirt and any loose feathers. Treat spills and stains as soon as possible by wiping with a damp cloth, do not treat with chemical cleaners or scrub as this can alter the fabrics appearance. We recommend contacting a specialist fabric cleaner to treat difficult stains. To prolong the life of your upholstery, we recommend annual cleaning by a specialist fabric cleaner. Direct sunlight may cause colour change and aging of your fabric, for best performance we recommend positioning your furniture out of direct UV light.

Stone

Regular cleaning is important to guard against the build-up of potentially damaging influences. It is advisable to reserve cleaning cloths exclusively for use on your stone finishes – residue from other cleaning products can work against our best efforts. Never use commercial cleaners on stone surfaces. They are generally not PH neutral and will affect the stone surface over time. A diluted mixture of Methylated Spirits (not dyed) and water (70/30) and paper towel / microfibre cloth is suitable everyday cleaner. Always dry off surfaces.

We recommend the use of clean white (or colourless) cloths for tabletops. There is no problem using synthetic sponges, but they do tend to leave streaks on a polished surface. Discard cleaning cloths when they become soiled.

Warranty

Jon Goulder Furniture provides a structural warranty for 10 Years from the date of purchase for furniture manufactured by Jon Goulder used in a private residential environments. This warranty covers the workmanship and structural integrity of the furniture. This warranty does not cover wear and tear, third party supplied components such as fabrics, leathers accidents, damage done in moving the furniture, mis-use, lack of care or neglect of the furniture. Care instructions are provided with all furniture and are also available on request.

This warranty does not cover deterioration of finishes, cracking or joint separation due to unsuitable placement in locations subject to direct sunlight, moisture or fluctuating temperatures. Please refer to our guide on suitable environments for our furniture prior to purchasing goods.

Nature of Natural Materials

As timber is a natural material, there can be variations in colour, textures and markings including knots and sapwood.

Each piece of timber is carefully selected, but each finished furniture piece will have its own unique appearance and characteristics.

Confirmation of Delivery Condition

The Client is required to accept the goods on arrival and any damage must be reported in writing within 24 hours of receiving the delivery at the site.

Liability

Jon Goulder Furniture does not accept any liability for any damage, however caused, which may directly or indirectly be suffered in connection with the product use.

Commercial Warranty

Warranty on products used in a commercial environment will vary from product to product. If a commercial warranty is required, please request information prior to purchasing goods.

Refund Policy

Please choose carefully as Jon Goulder Furniture does not refund or exchange furniture or interior items unless they are structurally faulty, in which case Mast Furniture will repair the fault or provide a replacement if deemed necessary by Jon Goulder Furniture.